

Job Name/Location:

Tag No.:

Date:

For:	File	Resubmit
	Approval	Other

PO No.:

Architect: GC:

Engr: Mech:

Rep: (Company) (Project Manager)



ARUM360BTE5 (a) ARUM144BTE5
Multi V™ 5 with LGRED° 208-230V ODU (b) ARUM216BTE5
30 Ton Dual Frame Heat Pump and Heat Recovery

Performance:

Cooling Mode:

Nominal Capacity (Btu/h)	360,000
Power Input ¹ (kW)	24.67

Heating Mode:

Nominal Capacity (Btu/h)	405,000
Power Input ¹ (kW)	28.29

Rated capacity is certified under AHRI Standard 1230. Ratings are subject to change without notice. Current certified ratings are available at www.ahridirectory.org.

Electrical:

	(a) ARUM144BTE5	(b) ARUM216BTE5
Frame		
Power Supply (V/Hz/Ø) ¹	208-230/60/3	208-230/60/3
MOP (A)	70	80
MCA (A)	51.1	60.3
Rated Amps (A)	46.1	54.2
Compressor A (A)	19.8	24.3
Compressor B (A)	18.3	21.9
Fan (A)	8.0	8.0

Piping:²

	(a) ARUM144BTE5	(b) ARUM216BTE5
Frame		
Refrigerant Charge (lbs.)	26.5	37.5
Liquid (in., O.D.)	1/2 Braze	5/8 Braze
High Pressure Vapor (Heat Recovery only; in, O.D.)	7/8 Braze	1-1/8 Braze
Low Pressure Vapor (in., O.D.)	1-1/8 Braze	1-1/8 Braze

Standard Features:

- Advanced Smart Load Control
- Intelligent Heating
- HiPOR (High Pressure Oil Return)
- Smart Oil Control
- Night Quiet Operation
- Fault Detection and Diagnosis
- Active Refrigerant Control
- Variable Heat Path Exchanger
- Subcooling and Vapor Injection Control
- Liquid Cooled Inverter Controller
- Advanced Comfort Cooling

Required Accessories:

- ARCNB21 (Frame Connector Y-branch, 3 pipe heat recovery)
- ARCNN21 (Frame Connector Y-branch, 2 pipe heat pump)

Optional Accessories:

- Air Guide - ZAGDKA52A (2 required)
- Hail Guard Kit - ZHGDKA52A (2 required)
- Low Ambient Baffle Kit - ZLABKA52A (2), Control Kit - PRVC2 (1 per system)
- Base Pan Heater - ZPLT1A52A

**Cooling range with the Low Ambient Baffle Kit (sold separately) is -9.9°F to +122°F and is achieved only when all indoor units are operating in cooling mode. Does not impact heat recovery system synchronous operating range.

For continual product development, LG reserves the right to change specifications without notice.

© LG Electronics Canada, Inc., North York, ON. All rights reserved. "LG Life's Good" is a registered trademark of LG Corp. /www.lgvr.com

Operating Range:

Cooling (°F DB)**	5 - 122
Heating (°F WB)	-22 - 61
Synchronous	
Cooling Based (°F DB)	14 - 81
Heating Based (°F WB)	14 - 61

Unit Data:

Refrigerant Type	R410A
Refrigerant Control	EEV
Max. Number of Indoor Units ³	58
Sound Pressure ⁴ dB(A)	66.0
Weight	
Frame	(a) ARUM144BTE5 (b) ARUM216BTE5
Net (lbs.)	639 666
Shipping (lbs.)	666 694
Communication Cable (No x AWG) ⁵	2 x 18
Heat Exchanger Coating	Black Coated Fin™

Compressor:

Type	HSS DC Scroll
Quantity	4
Oil / Type	PVE / FVC68D

Fan:

Type	Propeller
Quantity (a) + (b)	4
Motor Drive	Brushless Digitally Controlled Direct
Air Flow Rate (a) + (b) (CFM)	22,600

Notes:

1. Power wiring cable size must comply with the applicable local and national codes. Cables terminate at each frame.
2. For main pipe segment size, refer to the LATS Multi V tree diagram.
3. The combination ratio must be between 50-130%.
4. Sound pressure levels are tested in an anechoic chamber under ISO Standard 3745 for the combination of outdoor units.
5. Communication cable between ODU and IDUs must be 2-conductor, 18 AWG, twisted, stranded, and shielded. Ensure the communication cable shield is properly grounded to the Master ODU chassis only. Do not ground the communication cable at any other point. Wiring must comply with all applicable local and national codes.
6. Acceptable operating voltage: 187 - 253V
7. The order of these units on the submittal (i.e., a+b) does not represent the installation order. Highest capacity unit is used as the Master, followed by the smaller size as Slave 1.
8. Low ambient performance with LGRED° heat technology is included in Multi V 5 units produced after February 2019.



ARUM360BTE5

Multi V™ 5 with LGRED° 208-230V ODU

30 Ton Dual Frame Heat Pump and Heat Recovery

(a) ARUM144BTE5

(b) ARUM216BTE5



Tag No.: _____

Date: _____

PO No.: _____

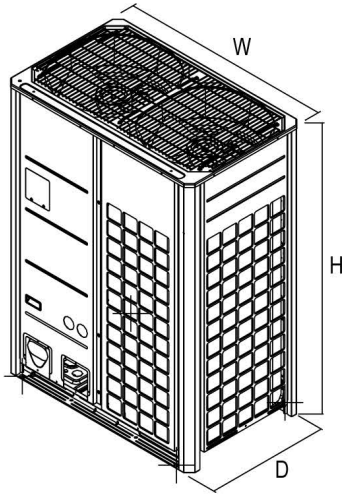

Typical Dual Frame Configuration

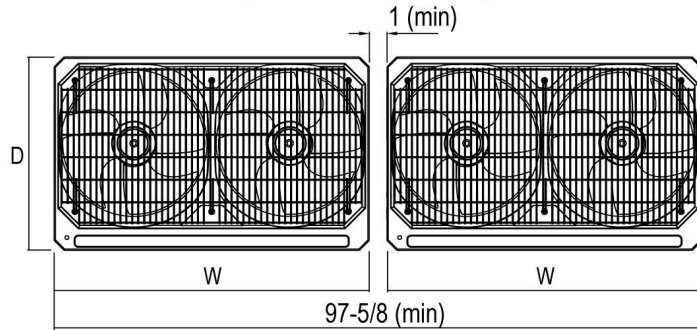

Note: Please refer to multi-frame placement information and piping rules in the Multi V 5 Engineering Manual and the Multi V 5 Installation Manual. Minimum spacing between frames is 1 inch.

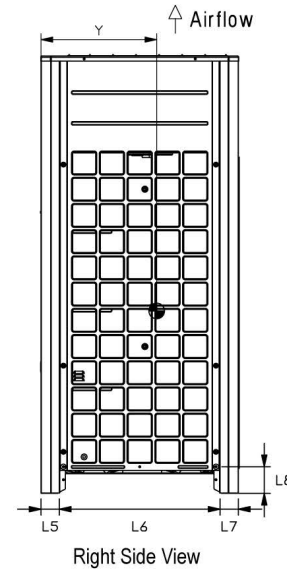
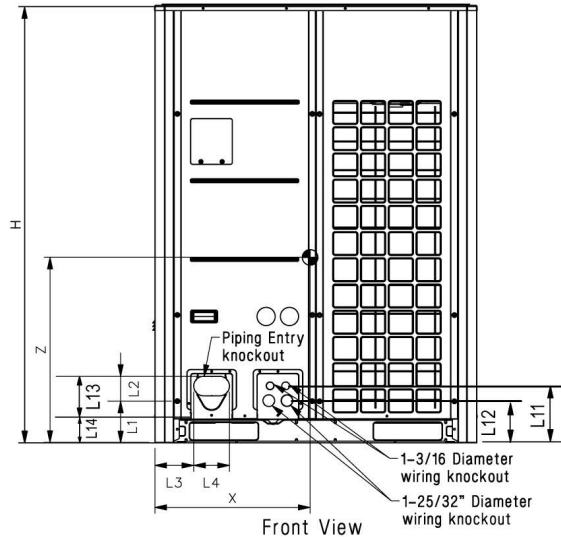
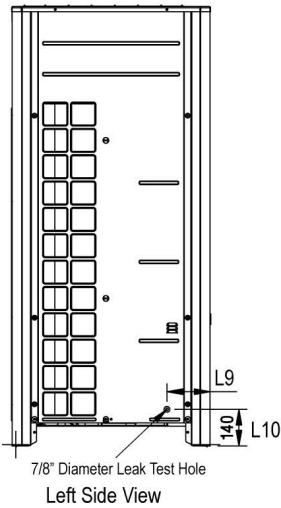

W	48-13/16"
H	66-17/32"
D	29-29/32"
L1	6-5/16"
L2	3-3/4"
L3	5-29/32"
L4	5-13/32"
L5	2-25/32"
L6	24-9/32"
L7	2-25/32"
L8	4-1/32"
L9	6-1/2"
L10	5-9/16"
L11	8-5/8"
L12	6-7/16"
L13	9-15/16"
L14	3-5/8"

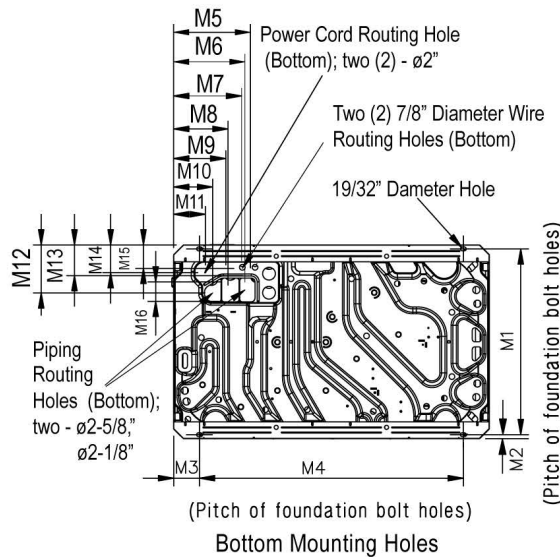
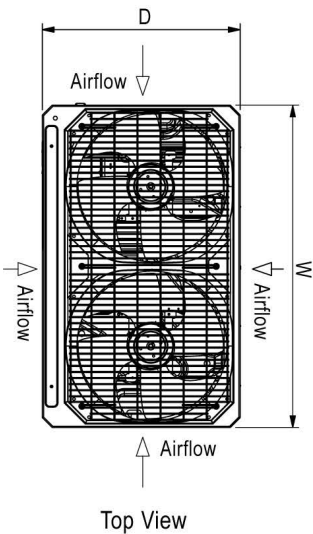

M1	28-25/32"
M2	5/8"
M3	3-15/16"
M4	40-15/16"
M5	11-15/16"
M6	11-1/16"
M7	10-1/2"
M8	8-7/16"
M9	8-1/8"
M10	6-1/16"
M11	4-15/16"
M12	7-1/2"
M13	4-13/16"
M14	4-5/16"
M15	3-5/8"
M16	3"

Center of Gravity

X	23-7/32"
Y	15-5/8"
Z	25-9/16"

All dimensions have a tolerance of ± 0.25 in. [Unit: inch]

